

Silicon TVS diodes

- ESD / transient protection of CAN/LIN bus networks power supply lines according to:
IEC61000-4-2 (ESD): $\pm 30\text{kV}$ (air / contact)
IEC61000-4-4 (EFT): 80 A (5/50 ns)
IEC61000-4-5 (surge): 5 A (8/20 μs)
ISO7637-2: Pulse 1 (max. 50 V),
Pulse 2 (max. 125 V), Pulse 3a, b (max.800 V)
- Max. working voltage: 24 V
- Low capacitance: 24 pF typ.
- Low clamping voltage: < 41 V
- Extremely low reverse current: < 1 nA typ.
- Pb-free (RoHS compliant) package

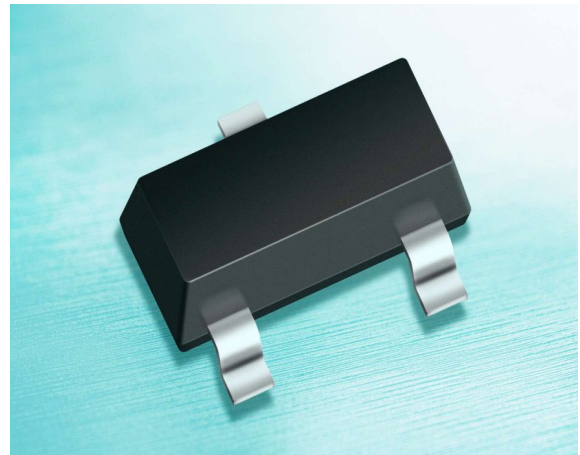

Applications

- Low and High-Speed CAN
- Fault Tolerant CAN
- Industrial control networks
- 12/24 V DC power supply lines



ESD24VS2U

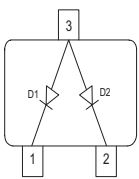

Type	Package	Configuration	Marking
ESD24VS2U	SOT23	2 lines, uni-directional*	EUs

* 1 line, bi-directional between pins 1 and 2, if pin 3 is not connected

Maximum Ratings at $T_A = 25^\circ\text{C}$, unless otherwise specified

Parameter	Symbol	Value	Unit
ESD contact discharge ¹⁾	V_{ESD}	30	kV
Peak pulse current ($t_p = 8 / 20 \mu\text{s}$) ²⁾	I_{pp}	5	A
Peak pulse power ($t_p = 8 / 20 \mu\text{s}$) ²⁾	P_{pk}	230	W
Operating temperature range	T_{op}	-55...150	°C
Storage temperature	T_{stg}	-65...150	

Electrical Characteristics at $T_A = 25^\circ\text{C}$, unless otherwise specified

Parameter	Symbol	Values			Unit
		min.	typ.	max.	

Characteristics

Reverse working voltage	V_{RWM}	-	-	24	V
Breakdown voltage $I_{\text{(BR)}} = 1 \text{ mA}$	$V_{\text{(BR)}}$	26	-	32	
Reverse current $V_{\text{R}} = 24 \text{ V}$	I_{R}	-	<1	10	nA
Clamping voltage $I_{\text{PP}} = 1 \text{ A}, t_p = 8 / 20 \mu\text{s}$) ²⁾ $I_{\text{PP}} = 5 \text{ A}, t_p = 8 / 20 \mu\text{s}$) ²⁾	V_{CL}	-	30 36	34 41	V
Line capacitance ³⁾ $V_{\text{R}} = 0 \text{ V}, f = 1 \text{ MHz}$, (pins 1 to 2, pin 3 n.c.) $V_{\text{R}} = 0 \text{ V}, f = 1 \text{ MHz}$, (pins 1 or 2 to 3)	C_{T}	-	24 48	28 52	

¹⁾ V_{ESD} according to IEC61000-4-2. Device stressed with 10 positive / negative ESD pulses.

²⁾ I_{pp} according to IEC61000-4-5. Non-repetitive current pulse.

³⁾Total capacitance line to ground (per line)

Power derating curve $P_{pk} = f(T_A)$

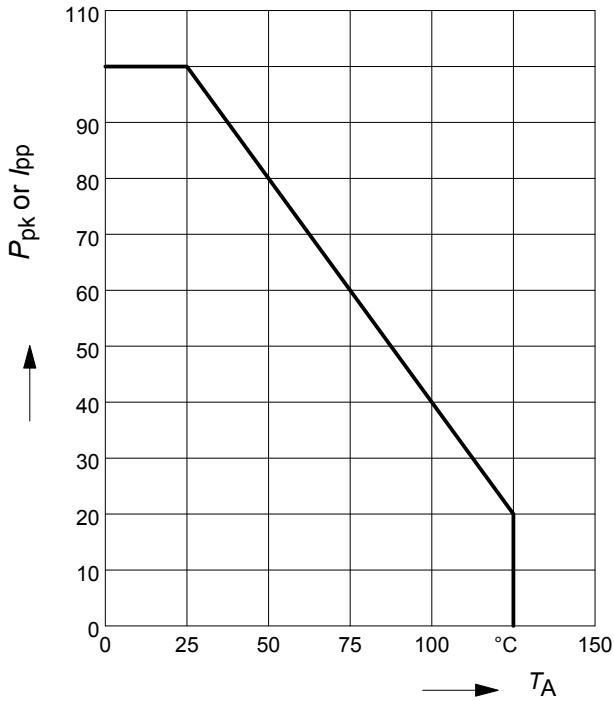

Clamping voltage, $V_{cl} = f(I_{pp})$

$t_p = 8 / 20 \mu s$

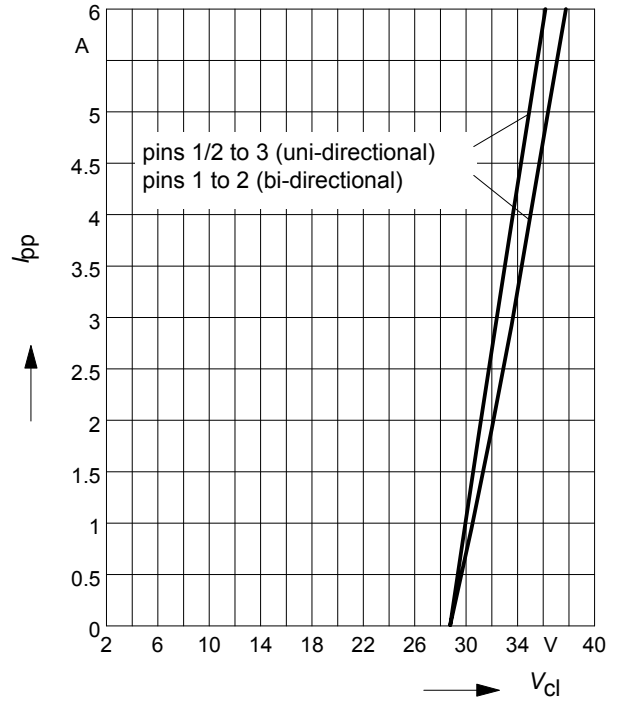

Reverse current $I_R = f(V_R)$

$T_A =$ Parameter, pins 1 / 2 to 3
(uni-directional)

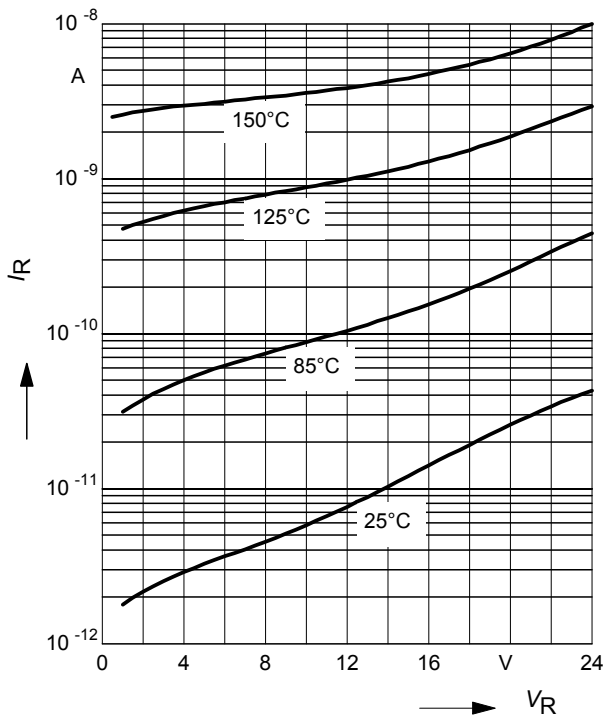

Breakdown voltage $V_{BR} = f(I_R)$

$T_A =$ Parameter, pins 1 to 2
(bi-directional)

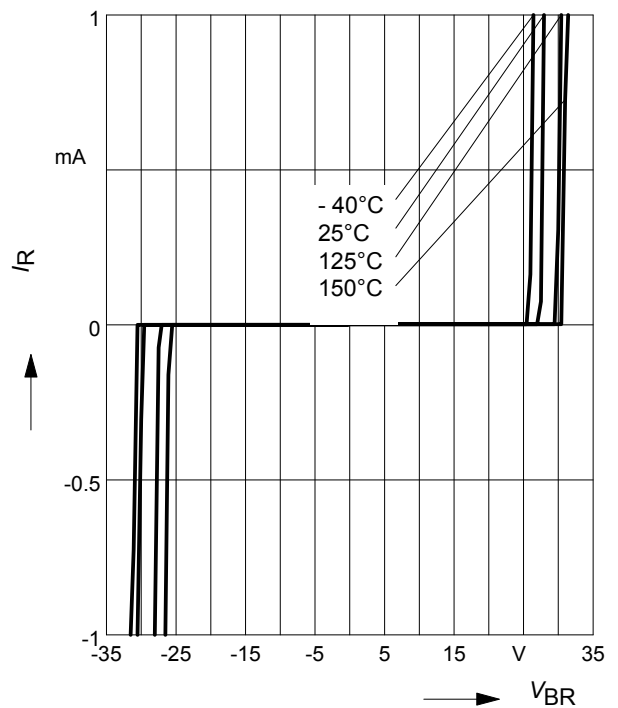

Line capacitance $C_T = f(V_R)$

$f = 1\text{MHz}$

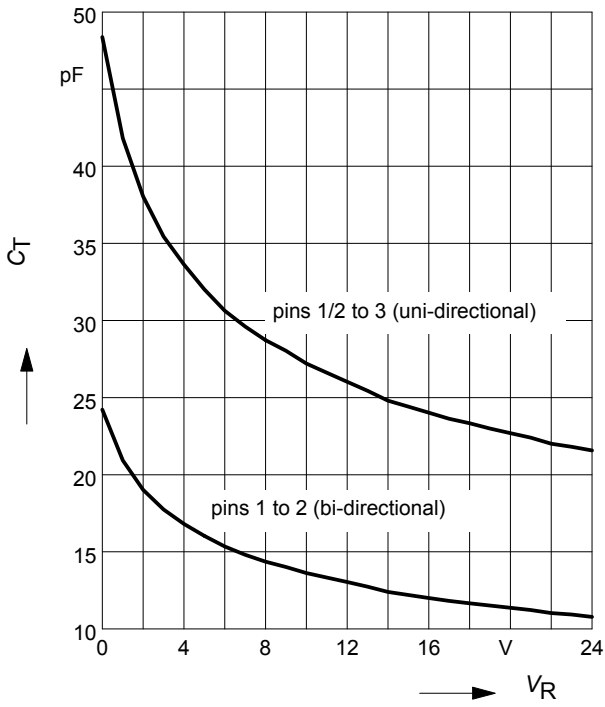

Application example ESD24VS2U (uni-directional)
 12V / 24V DC power supply line protection

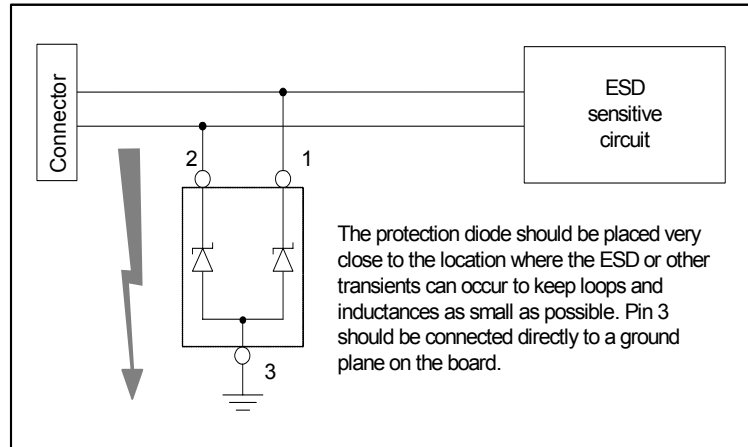

Application example ESD24VS2U (bi-directional)
 Single Wire CAN and LIN bus protection

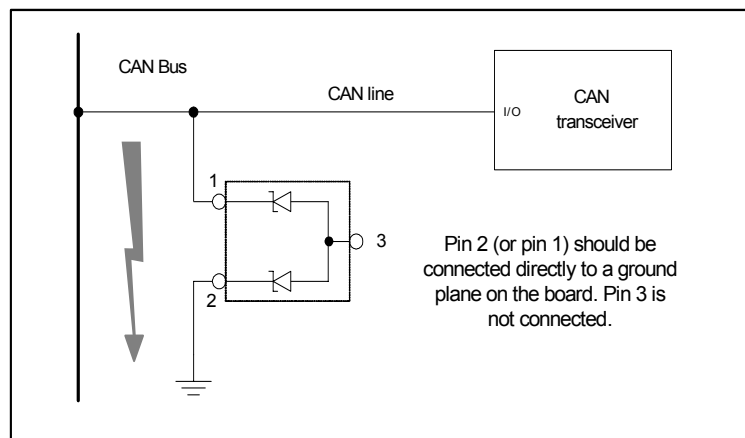

Clamping voltage according to ISO 7637-2: Pulse 1

Ri = 10 Ohm, td = 2 ms, 5000 pulses

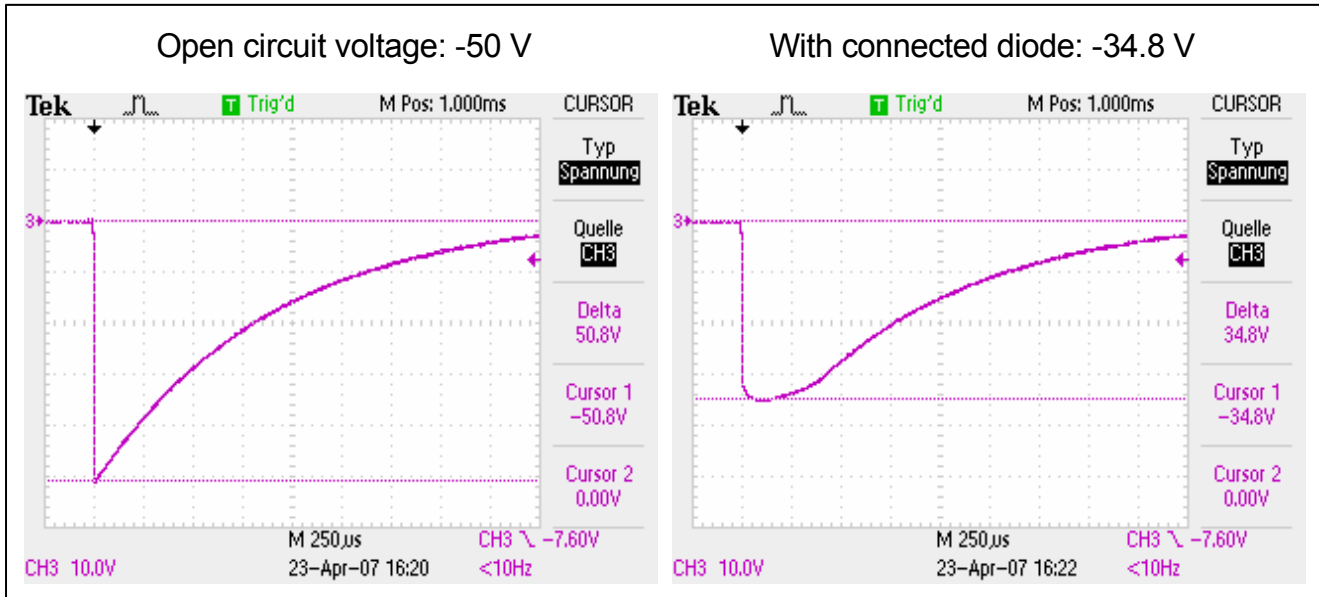

Clamping voltage according to ISO 7637-2: Pulse 2a

Ri = 10 Ohm, td = 2 us, 4000 pulses, 60 min

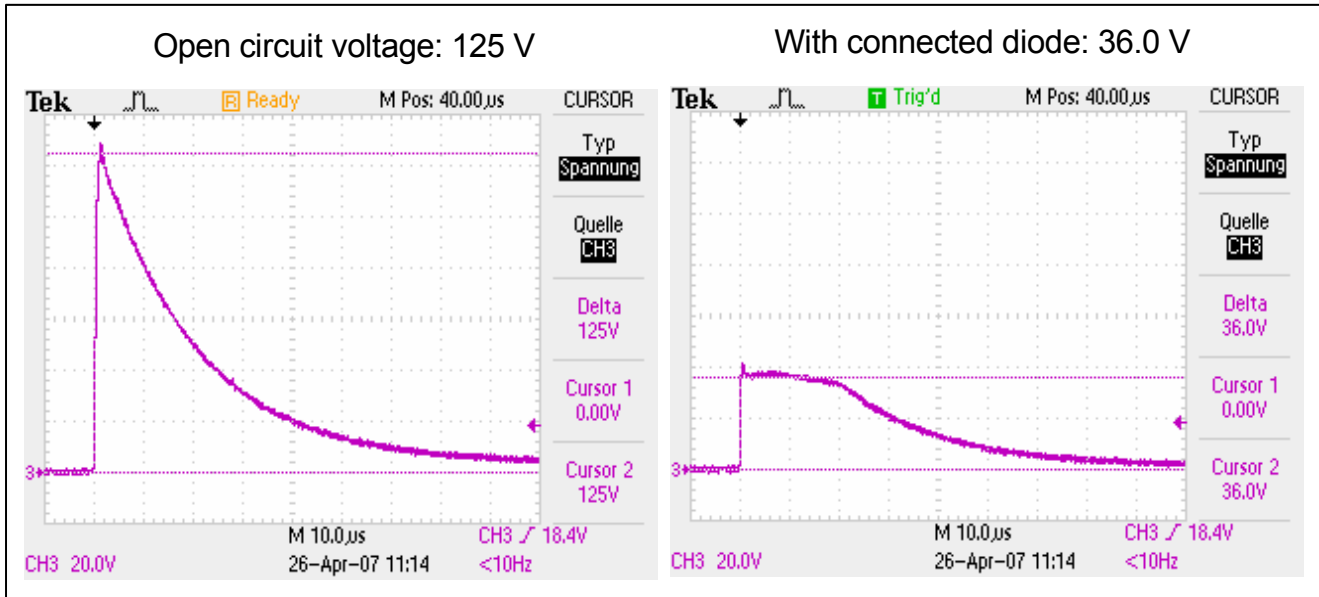

Clamping voltage according to ISO 7637-2: Pulse 3

Ri = 50 Ohm, td = 100 ns, 10 min

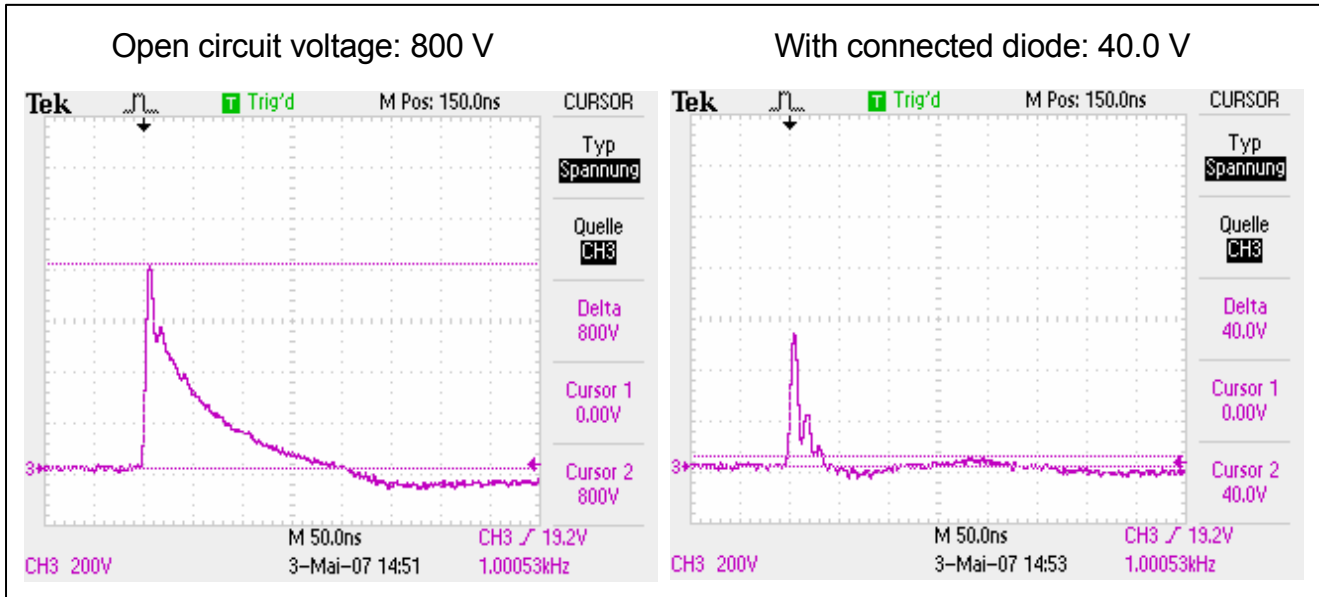

Package Outline

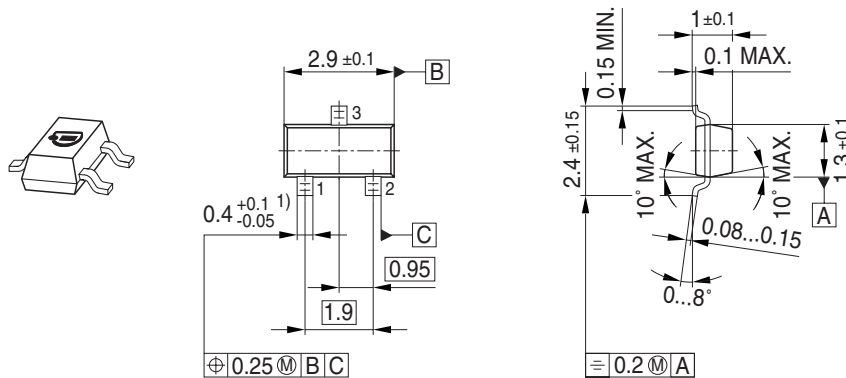

1) Lead width can be 0.6 max. in dambar area

Foot Print

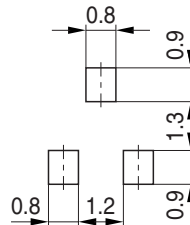

Marking Layout (Example)

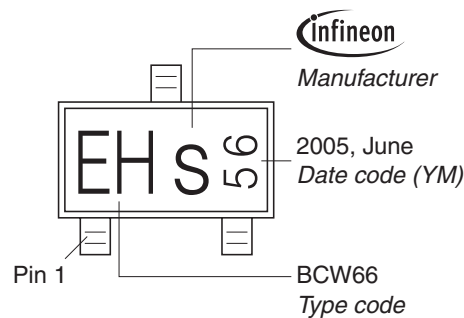

Standard Packing

Reel \varnothing 180 mm = 3.000 Pieces/Reel
 Reel \varnothing 330 mm = 10.000 Pieces/Reel

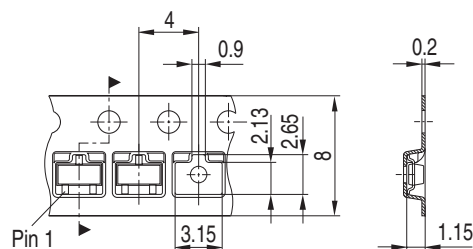

Edition 2009-11-16

**Published by
Infineon Technologies AG
81726 Munich, Germany**

**© 2009 Infineon Technologies AG
All Rights Reserved.**

Legal Disclaimer

The information given in this document shall in no event be regarded as a guarantee of conditions or characteristics. With respect to any examples or hints given herein, any typical values stated herein and/or any information regarding the application of the device, Infineon Technologies hereby disclaims any and all warranties and liabilities of any kind, including without limitation, warranties of non-infringement of intellectual property rights of any third party.

Information

For further information on technology, delivery terms and conditions and prices, please contact the nearest Infineon Technologies Office (www.infineon.com).

Warnings

Due to technical requirements, components may contain dangerous substances. For information on the types in question, please contact the nearest Infineon Technologies Office.

Infineon Technologies components may be used in life-support devices or systems only with the express written approval of Infineon Technologies, if a failure of such components can reasonably be expected to cause the failure of that life-support device or system or to affect the safety or effectiveness of that device or system. Life support devices or systems are intended to be implanted in the human body or to support and/or maintain and sustain and/or protect human life. If they fail, it is reasonable to assume that the health of the user or other persons may be endangered.

单击下面可查看定价，库存，交付和生命周期等信息

[>>Infineon Technologies\(英飞凌\)](#)

[>>点击查看相关商品](#)